

HUSH OVAL

by David Trubridge Ltd

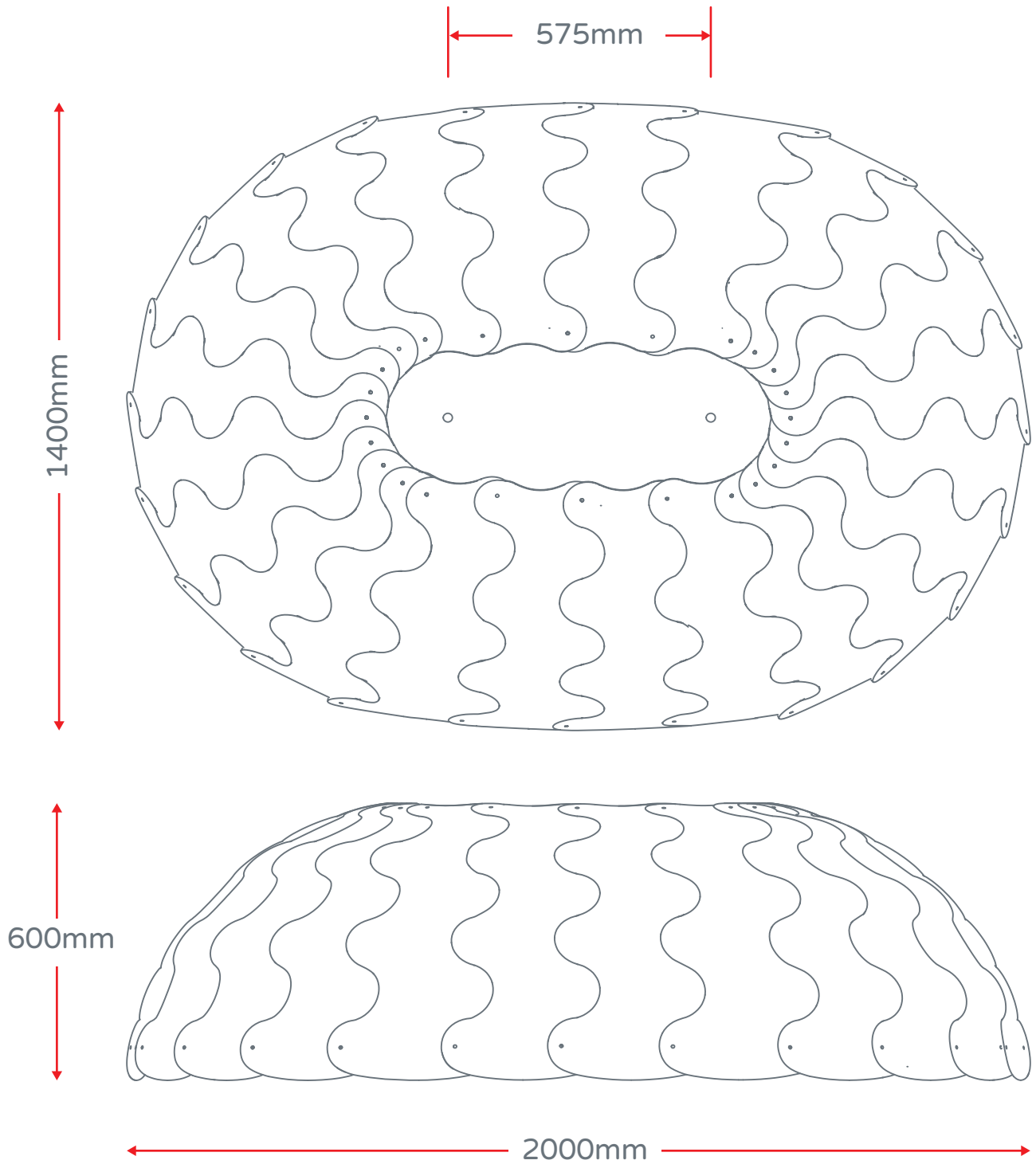

Overall Dimensions - Model: 1018-A



Contents (Not to scale)

Please double check all components are present and quantities are correct before beginning assembly

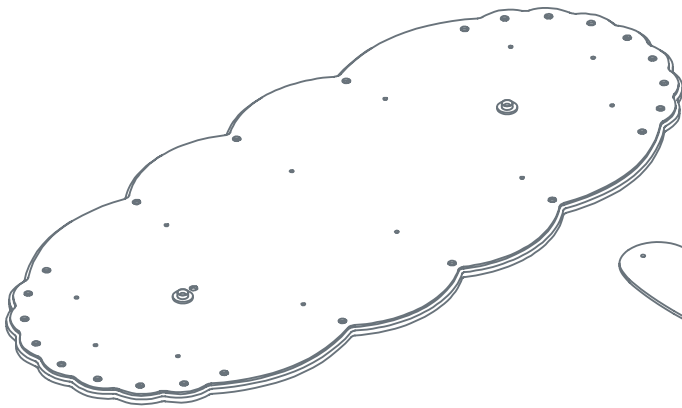

x1
Top Panel Assembly
(Power cable not shown)

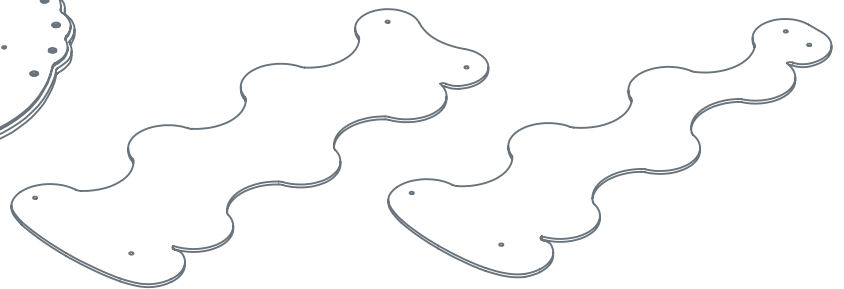

x8
Straight
Felt Panels

x16
Tapered
Felt Panels

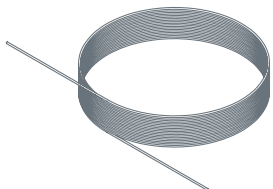

x2
3m Cables



x48 (+5)
Small Ratchet
Rivets (13mm)



x48 (+5)
Large Ratchet
Rivets (19mm)



x2
Cone Gripper
without Base

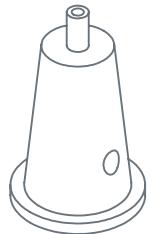

x2
Cone Gripper
with Base

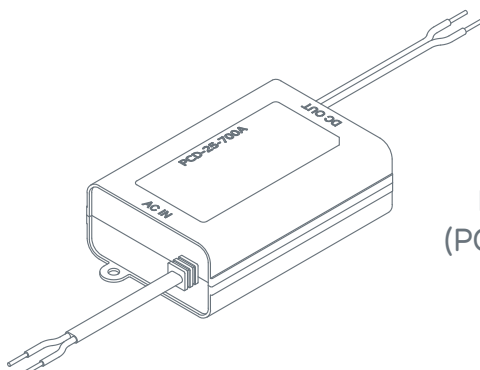

x1
LED Driver
(PCD-25-700A)

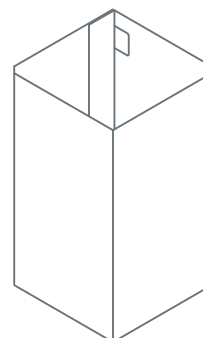

x2
Folded
Cardboard
Pillars

Step 1 - Top Panel Ratchet Rivet Assembly

Screw on x2 Cone Grippers (without bases) onto bases already attached to top panel assembly

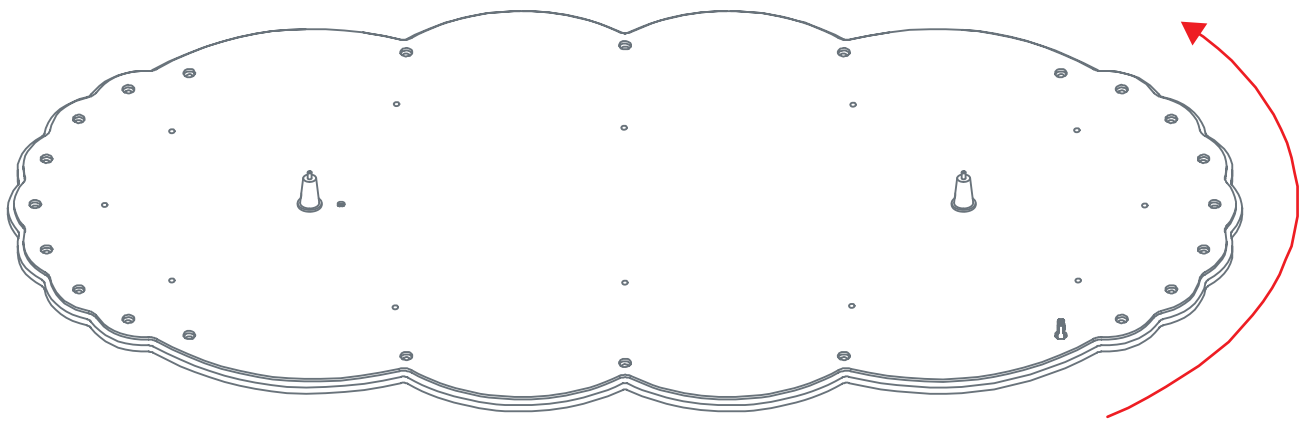
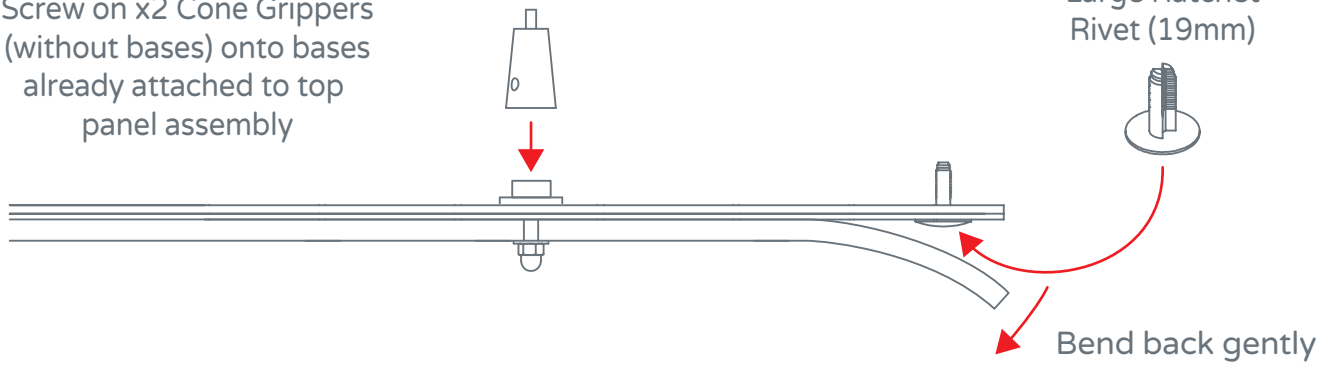

Insert Large Ratchet Rivets (19mm) in all holes around edge.

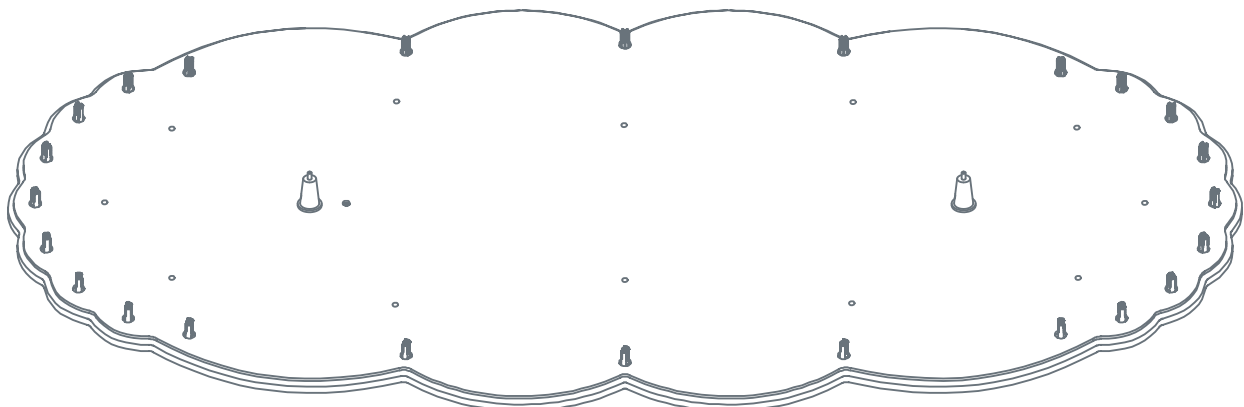

Step 2 - Pop out side panel plugs

Push out the 4 plugs per panel to make way for the plastic clips.

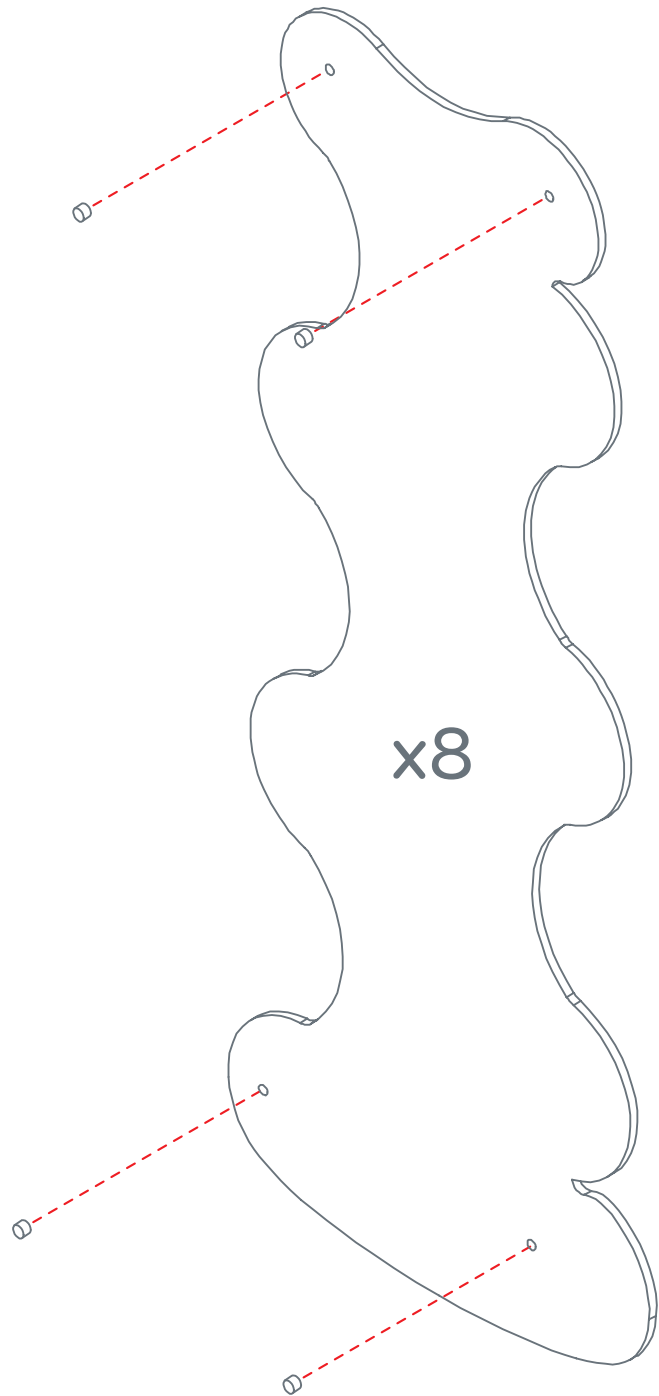
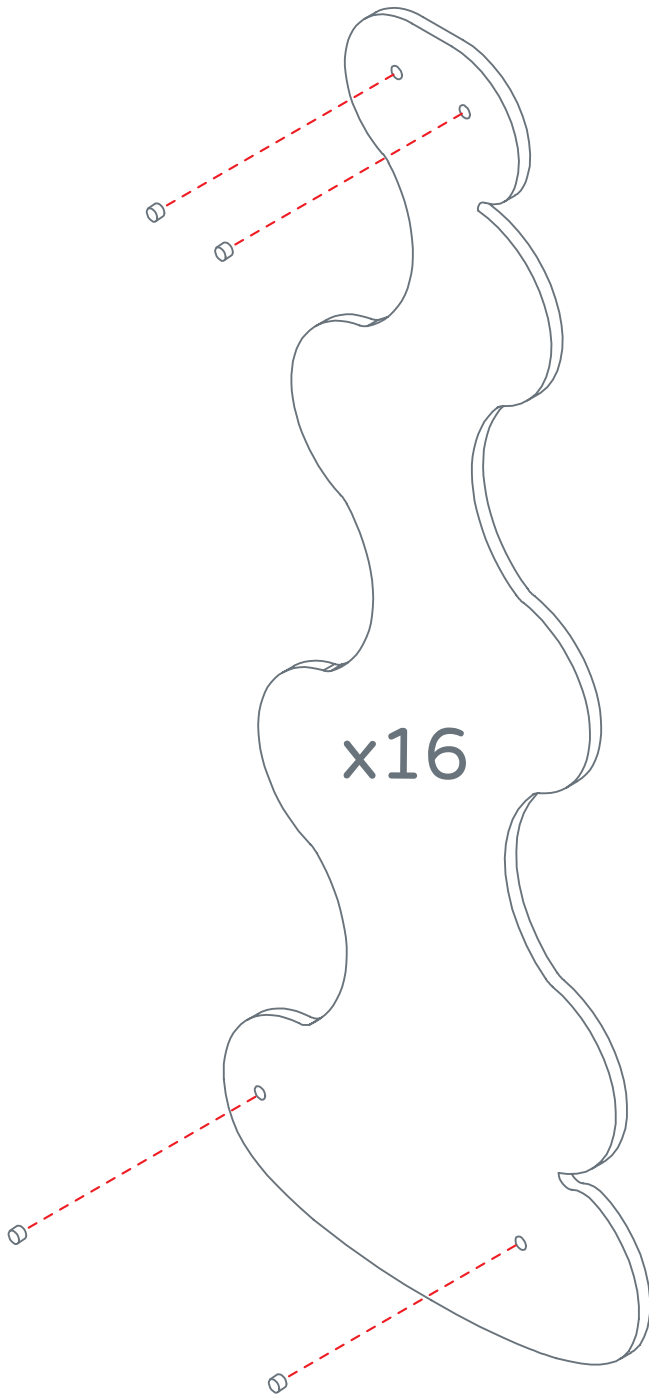

Step 3 - Top Panel to Side Panel Assembly

Assemble on a large clean surface or on floor.

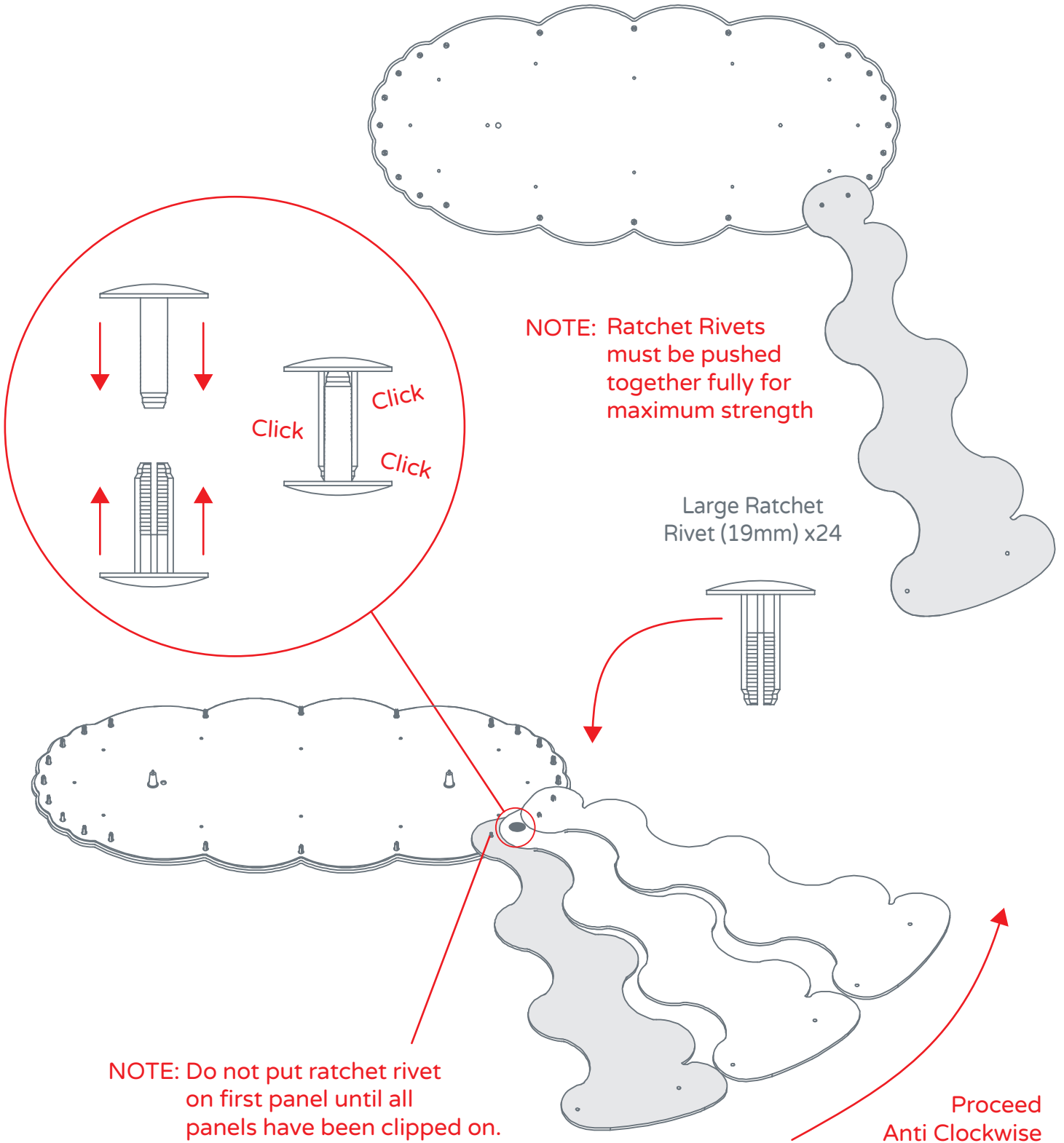

Step 4 - Top Panel to Side Panel Assembly Continued

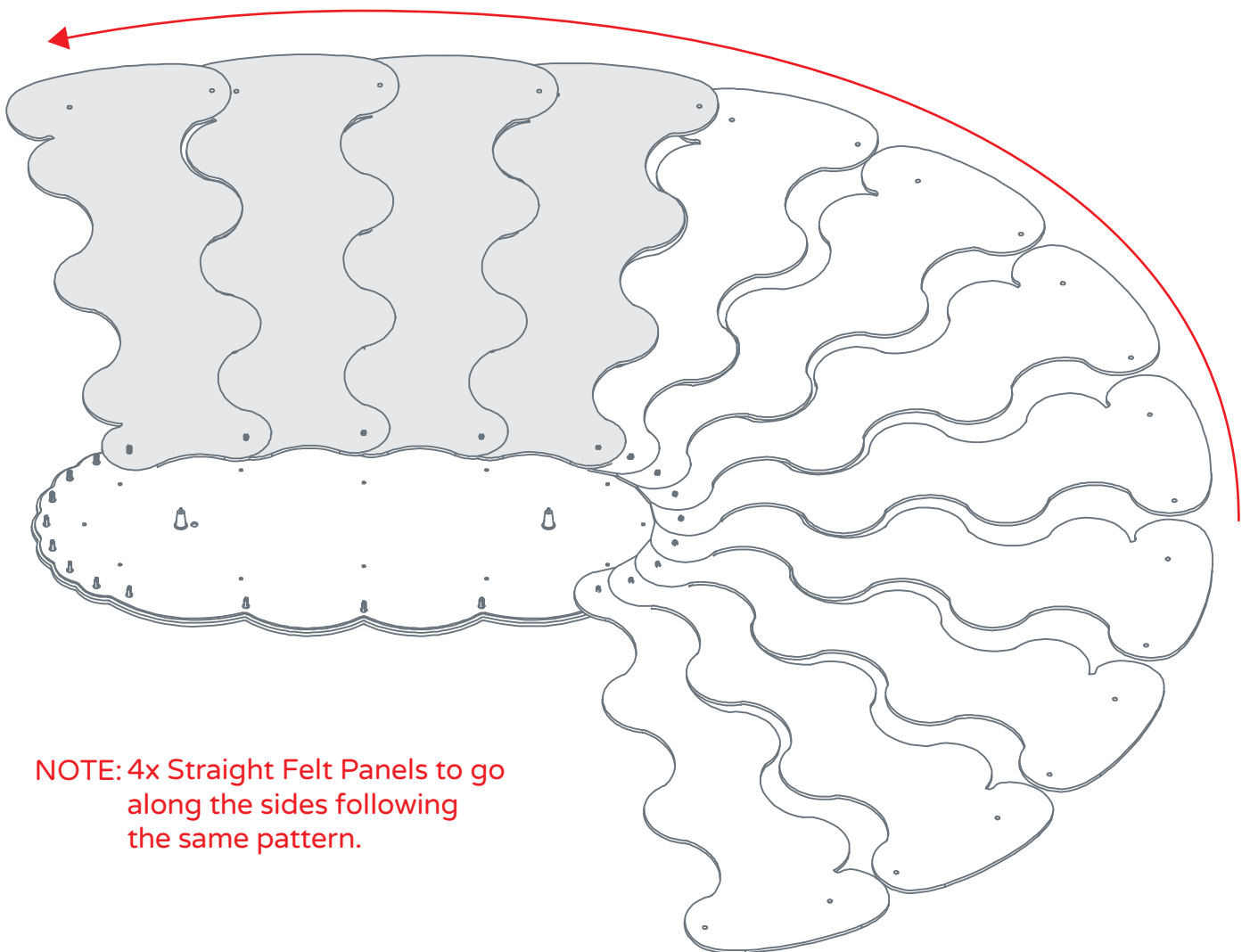

NOTE: 4x Straight Felt Panels to go along the sides following the same pattern.

Step 4 - Top Panel to Side Panel Assembly Continued

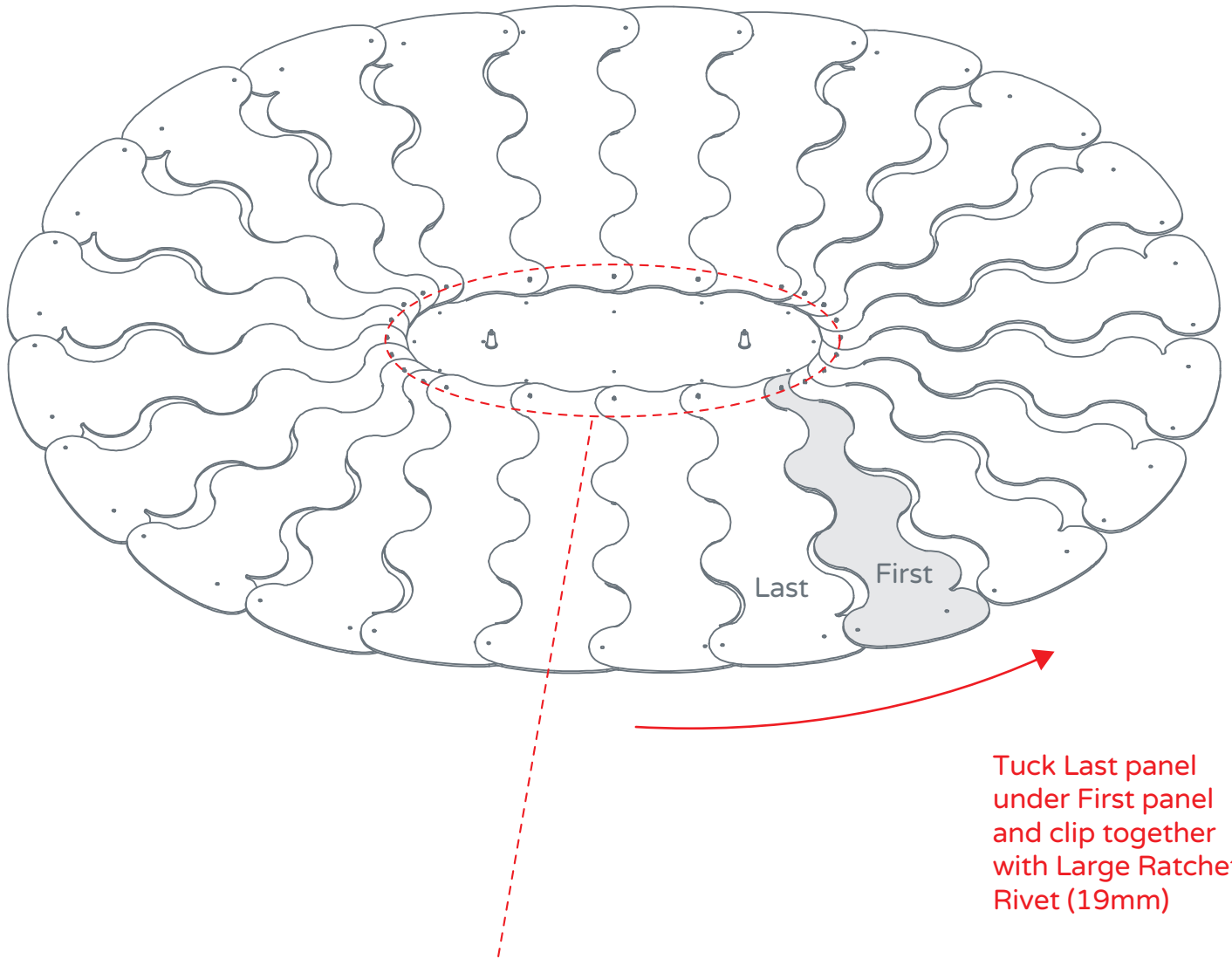

Tuck Last panel under First panel and clip together with Large Ratchet Rivet (19mm)

Cross Section Detail View of Top Panels overlapping.

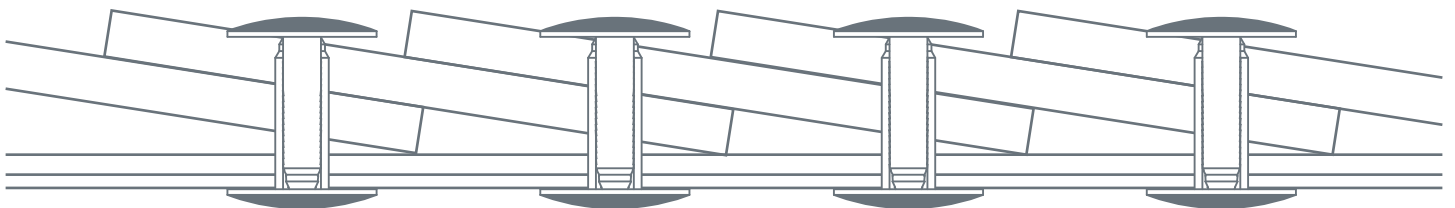

Step 5 - Lifting into shape

Insert cable into Gripper Cone and use it to lift the Hush Round approximately 600mm from the floor/surface.

The panels will begin to fall into their natural shape.

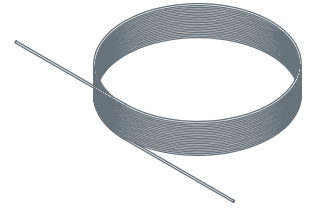

3m Cable (x2)

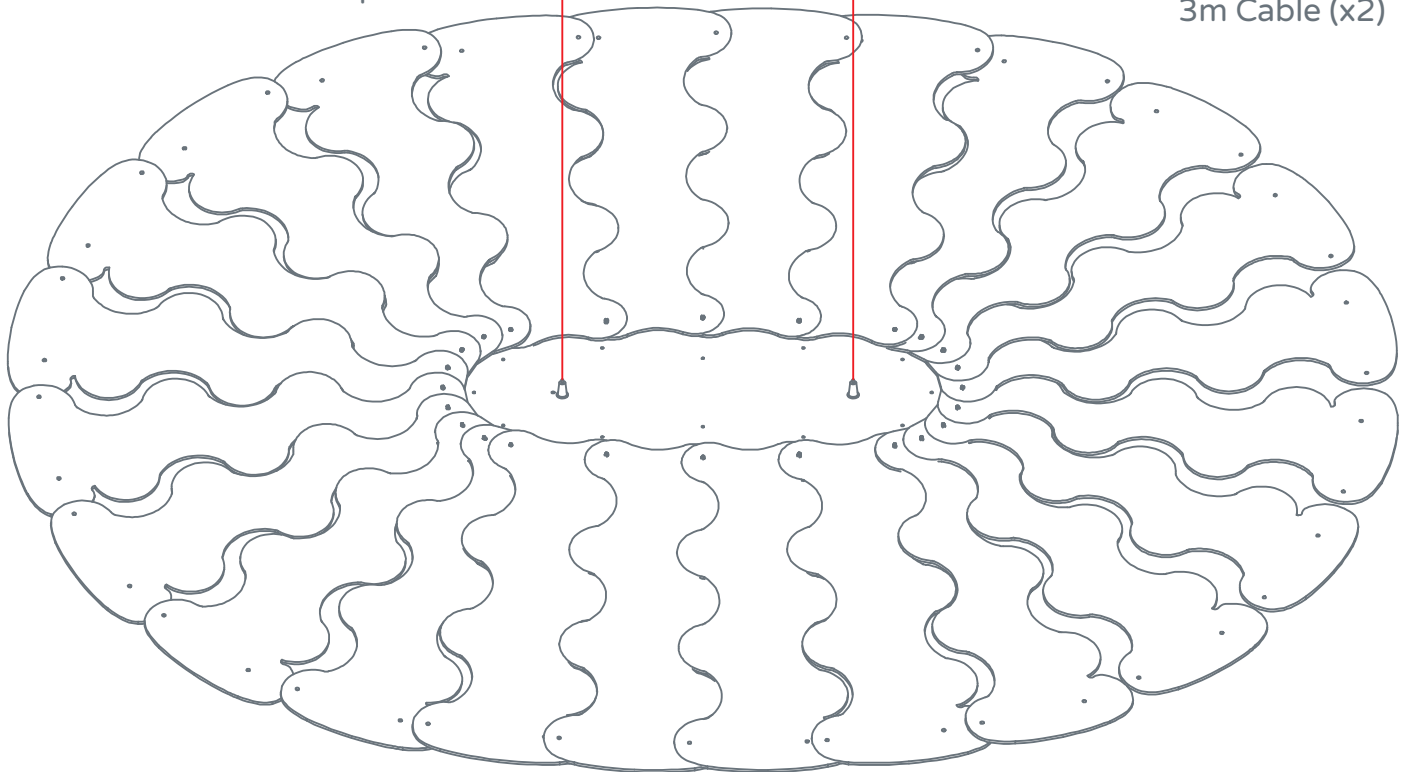

Use the folded cardboard pillar that was in the box to prop it up.

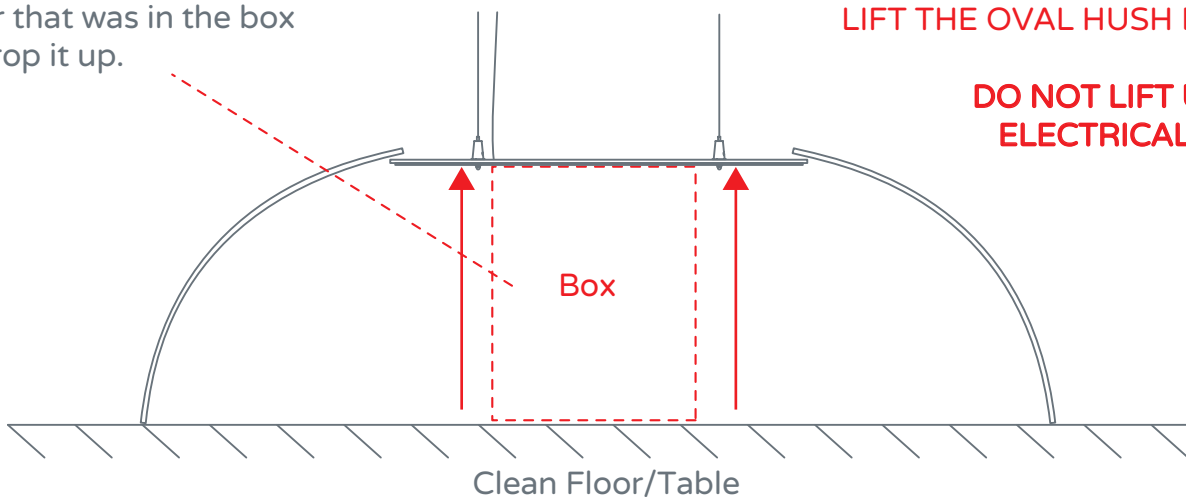

IMPORTANT:
ENSURE YOU ONLY USE THE
2x STEEL CABLES TO
LIFT THE OVAL HUSH LIGHT.

**DO NOT LIFT USING
ELECTRICAL WIRE**

Step 6A - Weaving of Panels - Exploded Detail

Bold Lines indicate the 'Ear' that sits on the outside of the Hush Round.
This weaving pattern is essential to lock the shape together

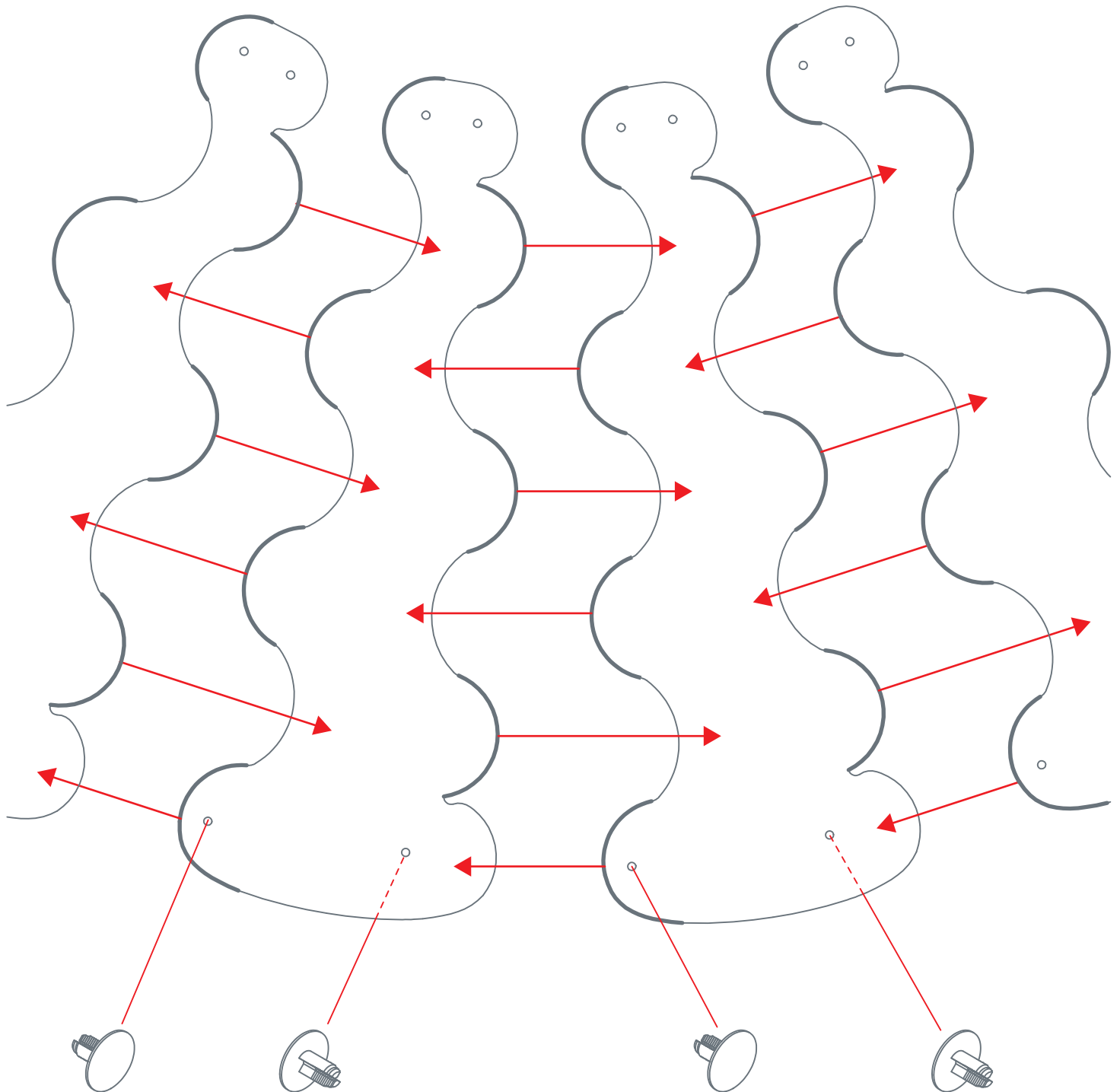

Once two panels are woven together, use two of the shorter Ratchet Rivets (13mm) to lock them together

Step 6B - Weaving of Panels - Finished Detail

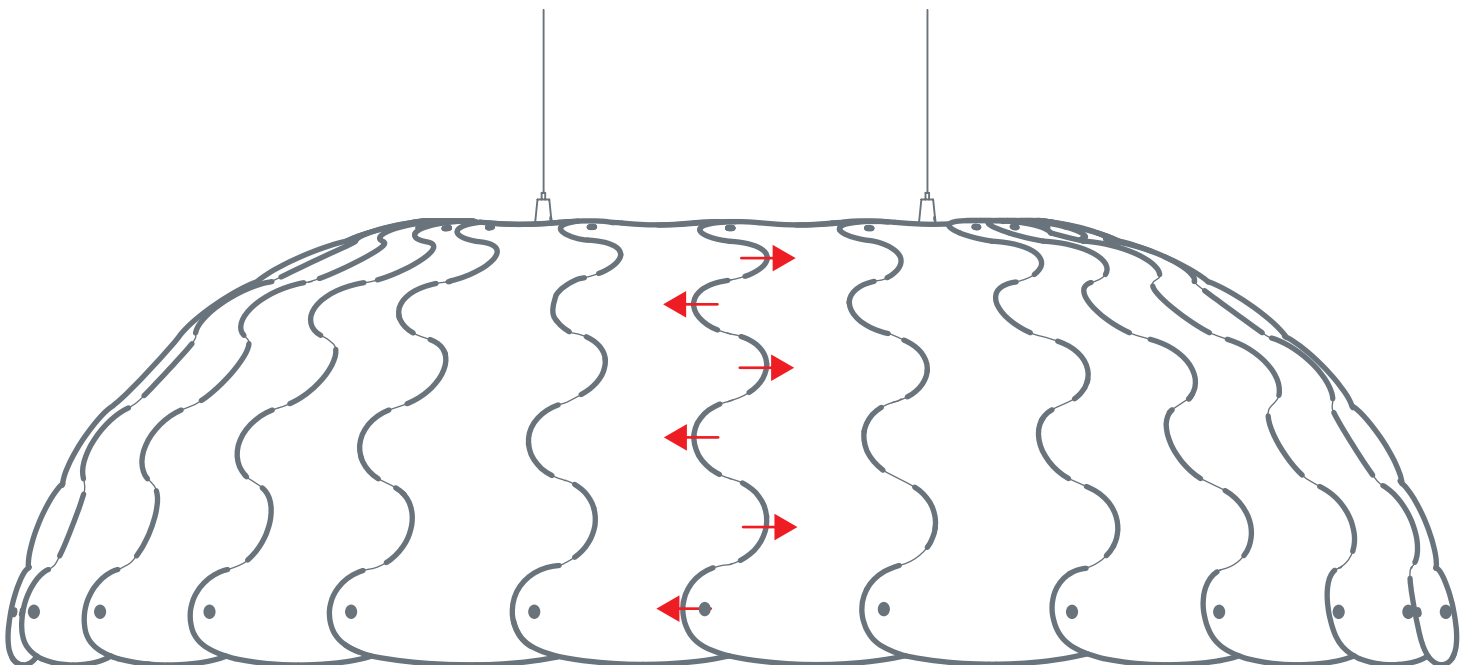
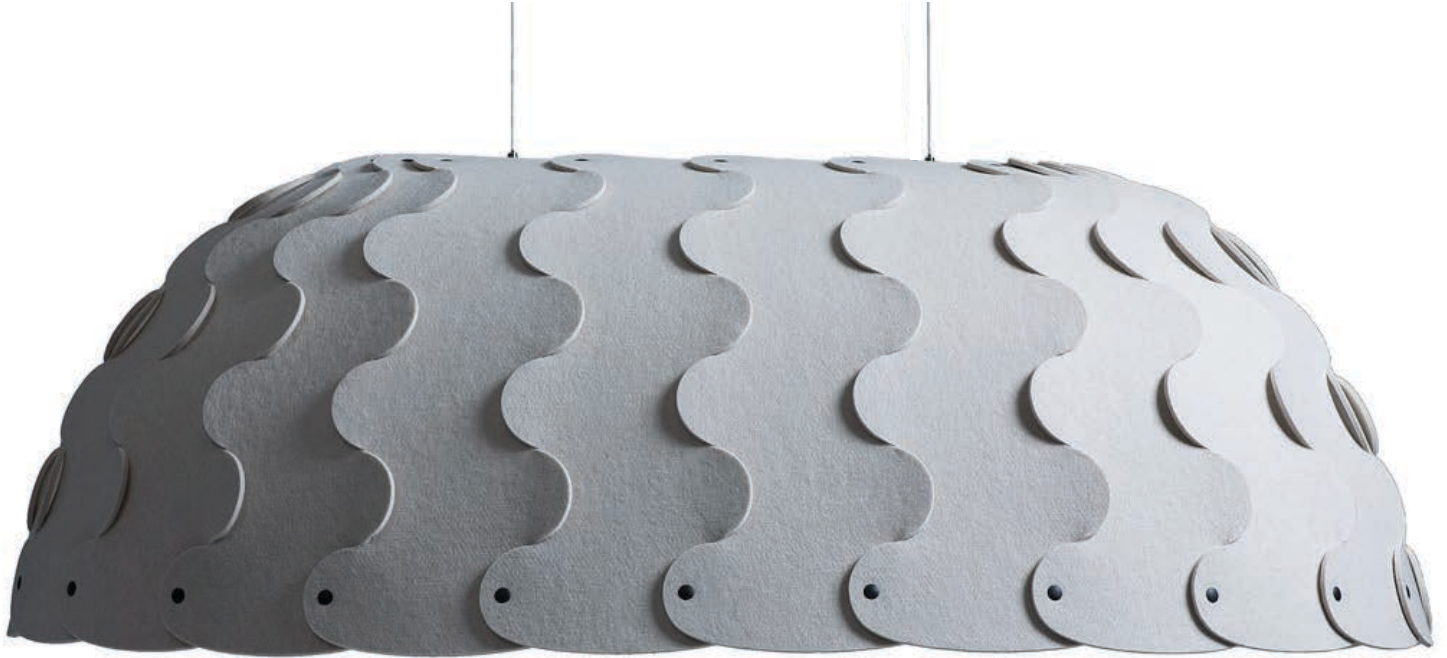

Bold Lines indicate the 'Ear' that sits on the outside of the Hush Oval.
This weaving pattern is essential to lock the shape together

Step 7 - Height Adjustment and Levelling

Ceiling Mounting Point.

If installing into wood use a countersunk timber screw (not supplied) to affix cone grip to ceiling.

If installing into concrete use countersunk anchor bolt (not supplied) to affix cone grip to ceiling.

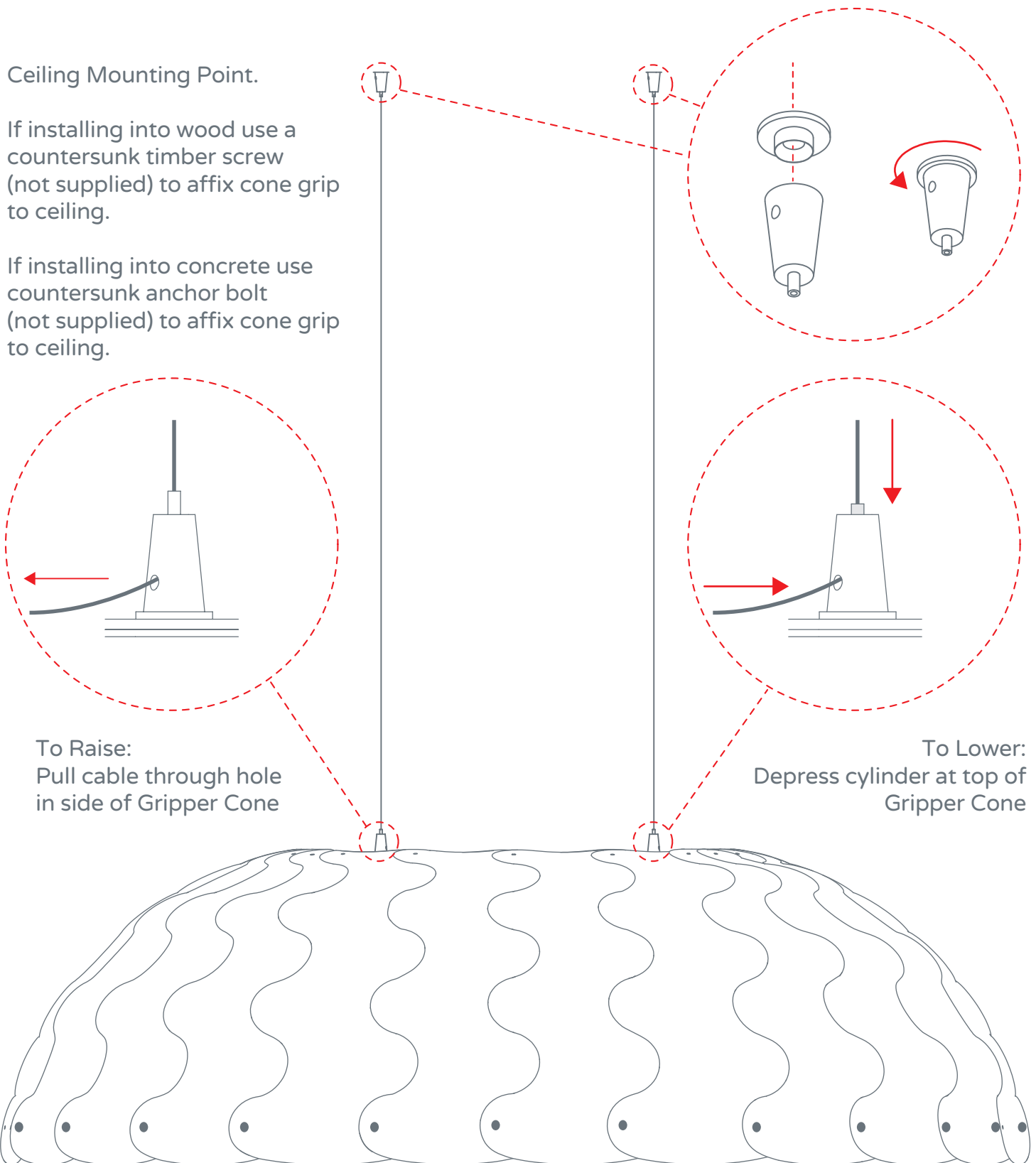

Step 8 - Typical LED driver placement with suspended ceiling.

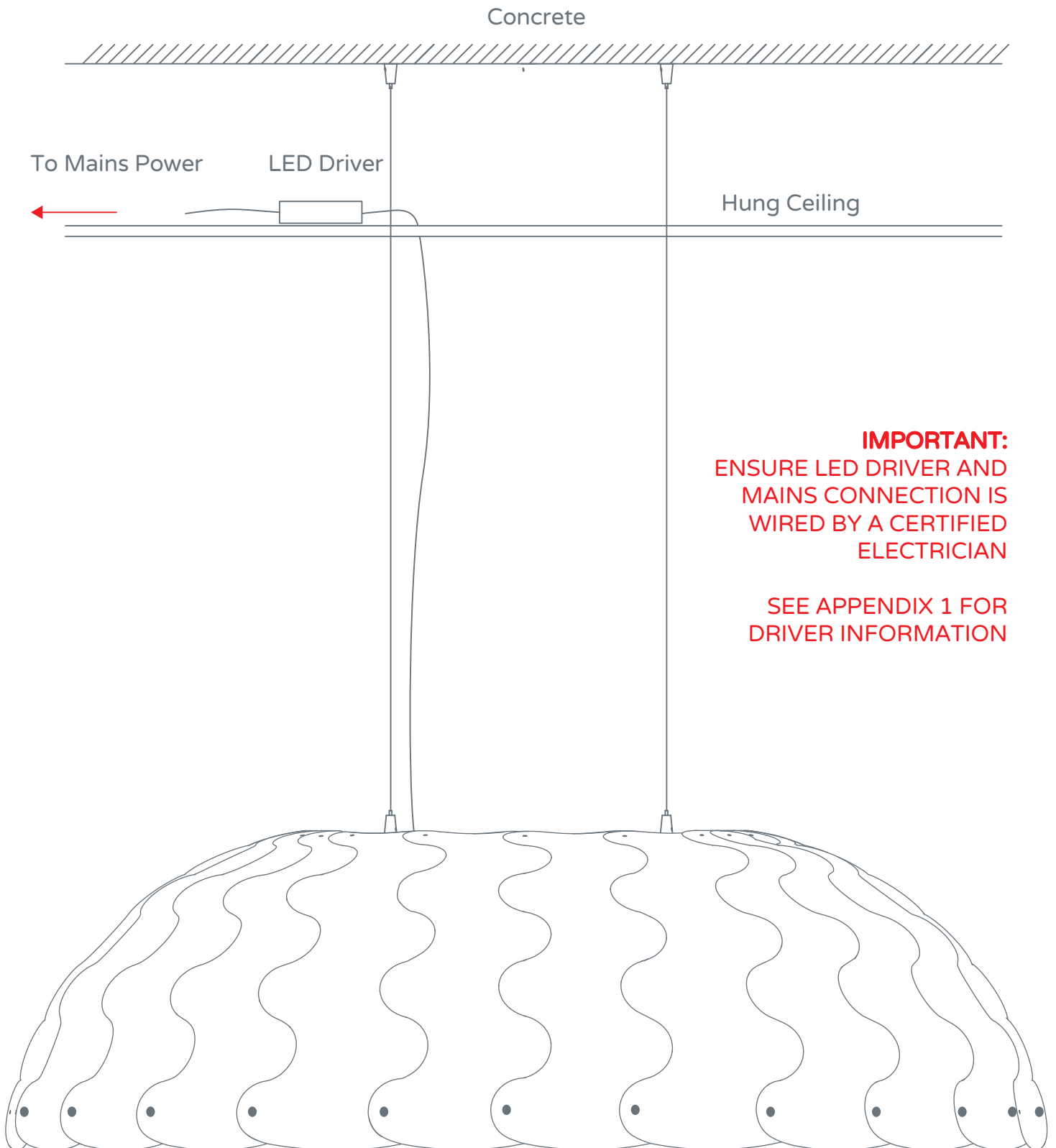

Appendix 1: LED Driver Diagram

MEANWELL 25W Single Output C Dimmable LED Power Supply
(PCD-25-700A)

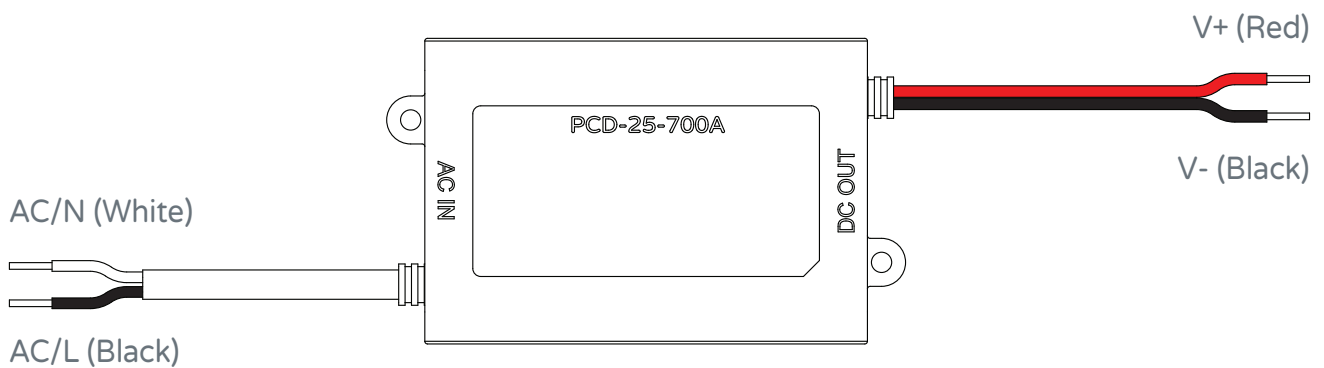

IMPORTANT:

THIS PRODUCT MUST BE INSTALLED IN ACCORDANCE WITH THE APPLICABLE INSTALLATION CODE BY A PERSON FAMILIAR WITH THE CONSTRUCTION AND OPERATION OF THE PRODUCT AND THE HAZARDS INVOLVED

Appendix 2: Access to LED Lights for maintenance

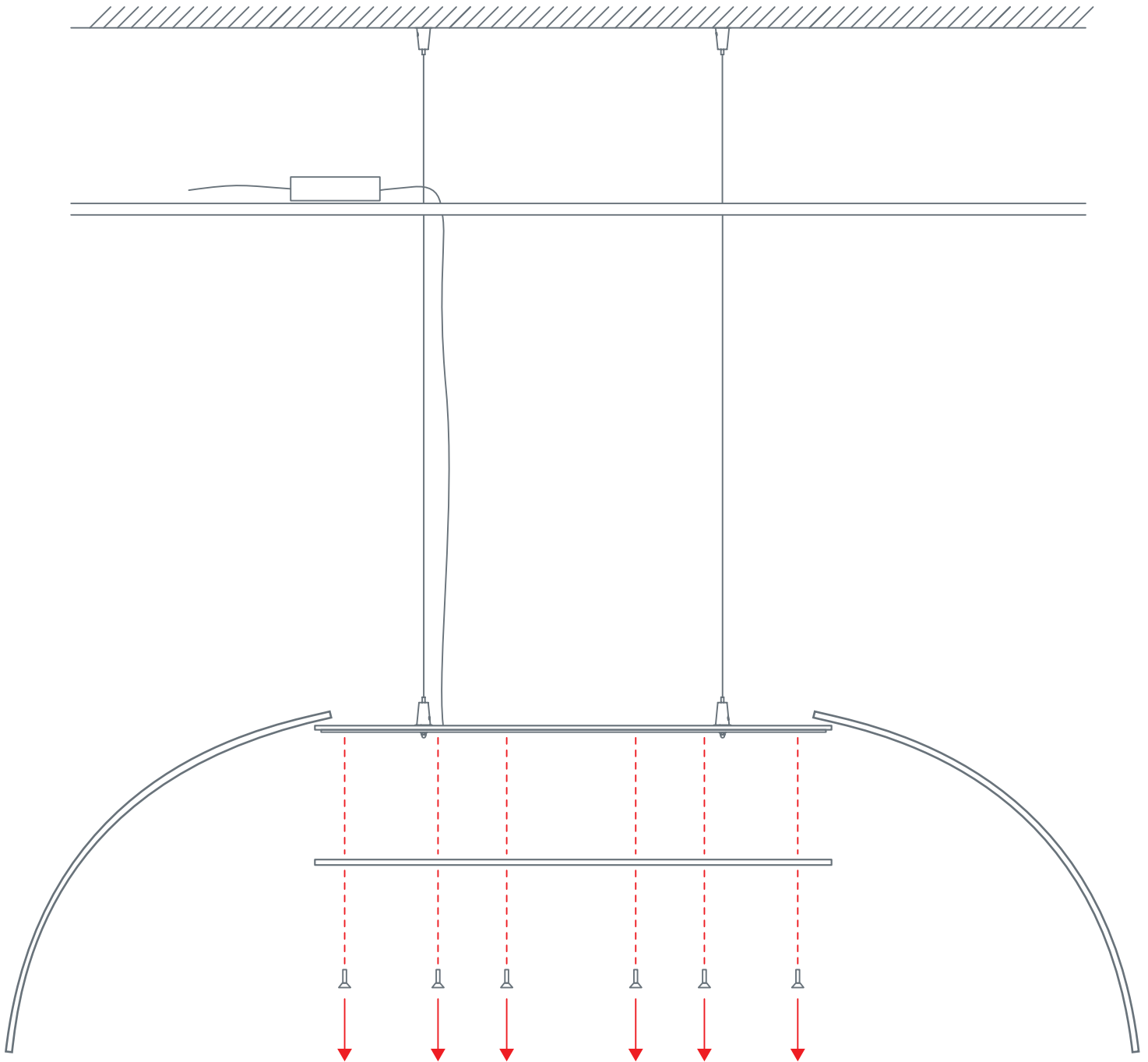

To gain access to the LEDs, remove the 12 small screws around the perimeter.

Appendix 3: Top Panel Sub Assembly

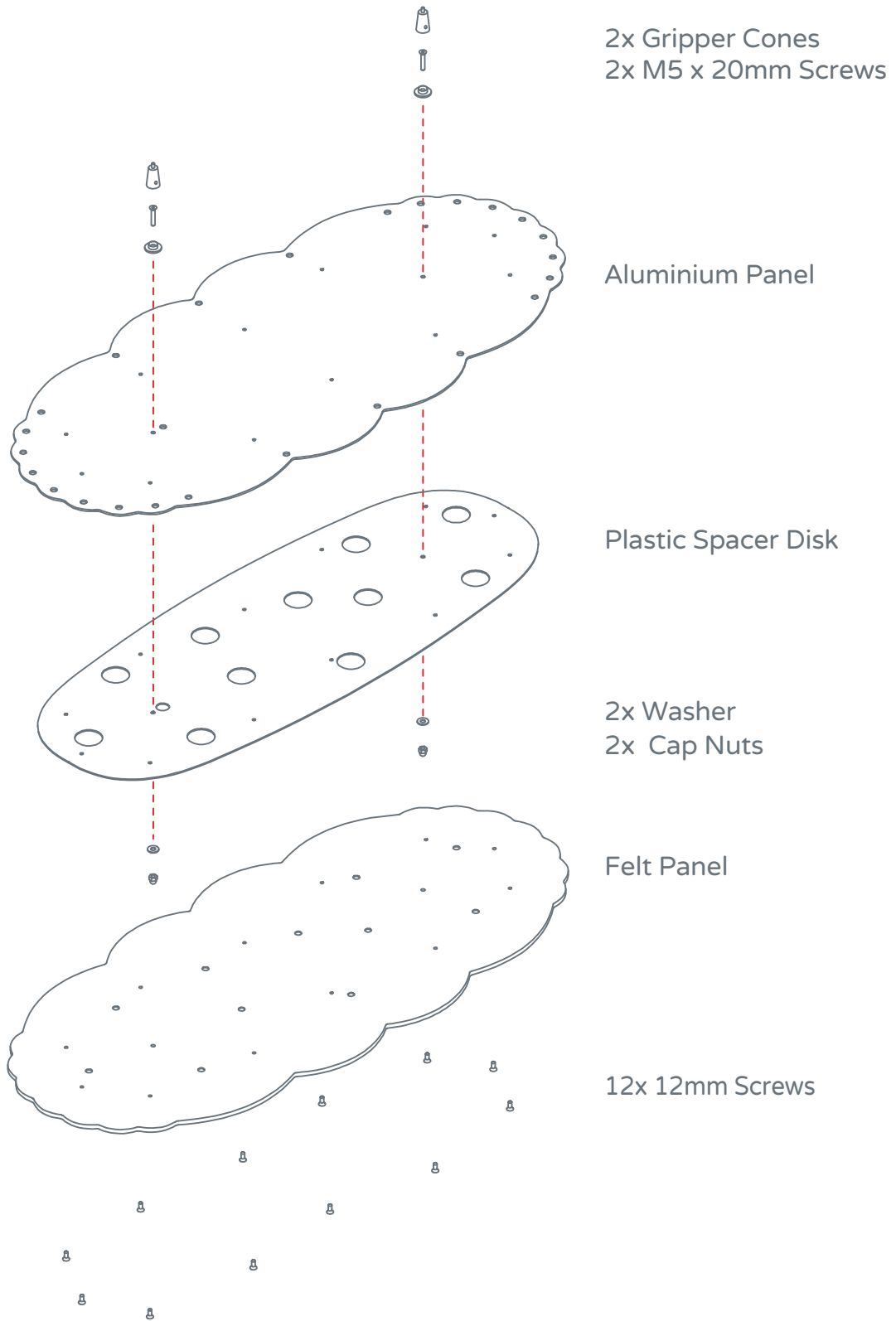

Exploded View